

Features

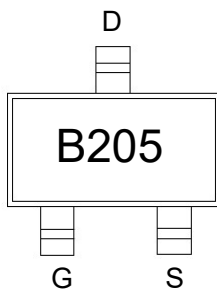
- Trench Power LV MOSFET technology
- High Power and current handling capability

Product Summary

V_{DS}	$R_{DS(ON) MAX}$	$I_D MAX$
20V	50mΩ@4.5V	2.5A
	65mΩ@2.5V	

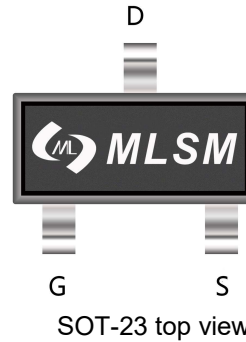
Application

- PWM application
- Load switch

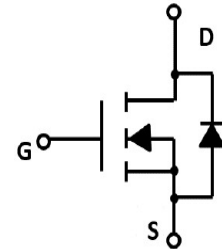


B205: Device code

Marking and pin assignment



SOT-23 top view



Schematic diagram



Halogen-Free

Absolute Maximum Ratings (TA=25°C unless otherwise noted)

Symbol	Parameter	Rating	Unit
--------	-----------	--------	------

Common Ratings (TC=25°C Unless Otherwise Noted)

V_{DS}	Drain-Source Breakdown Voltage	20	V	
V_{GS}	Gate-Source Voltage	±12	V	
T_J	Maximum Junction Temperature	150	°C	
T_{STG}	Storage Temperature Range	-50 to 155	°C	
I_S	Diode Continuous Forward Current	$T_c=25^\circ C$	2.5	A

Mounted on Large Heat Sink

I_{DM}	Pulse Drain Current Tested	$T_c=25^\circ C$	10	A
I_D	Continuous Drain Current	$T_c=25^\circ C$	2.5	A
P_D	Maximum Power Dissipation	$T_c=25^\circ C$	0.5	W
$R_{\theta JA}$	Thermal Resistance Junction-to-Ambient		178	°C/W

Ordering Information (Example)

Type	Package	Marking	Minimum Package(pcs)	Inner Box Quantity(pcs)	Outer Carton Quantity(pcs)	Delivery Mode
BSS205N	SOT-23	B205	3,000	45,000	180,000	7"reel

Electrical Characteristics (T _J =25°C unless otherwise noted)						
Symbol	Parameter	Condition	Min	Typ	Max	Unit
Static Electrical Characteristics @ T _J = 25°C (unless otherwise stated)						
BV _{(BR)DSS}	Drain-Source Breakdown Voltage	V _{GS} =0V, I _D =250μA	20	--	--	V
I _{DSS}	Zero Gate Voltage Drain Current	V _{DS} =20V, V _{GS} =0V	--	--	1	μA
I _{GSS}	Gate-Body Leakage Current	V _{GS} =±12V, V _{DS} =0V	--	--	±100	nA
V _{GS(th)}	Gate Threshold Voltage	V _{DS} =V _{GS} , I _D =250μA	0.45	--	1.2	V
R _{DS(on)}	Drain-Source On-State Resistance	V _{GS} =4.5V, I _D =2.5A	--	40	50	mΩ
		V _{GS} =2.5V, I _D =1.95A	--	55	65	mΩ
Dynamic Electrical Characteristics @ T _J = 25°C (unless otherwise stated)						
C _{ISS}	Input Capacitance	V _{DS} =10V, V _{GS} =0V, f=1MHz	--	222	--	pF
C _{OSS}	Output Capacitance		--	35	--	pF
C _{RSS}	Reverse Transfer Capacitance		--	25	--	pF
Switching Characteristics						
Q _g	Total Gate Charge	V _{DS} =10V, I _D =2.5A, V _{GS} =10V	--	3.6	--	nC
Q _{gs}	Gate Source Charge		--	0.9	--	nC
Q _{gd}	Gate Drain Charge		--	0.75	--	nC
t _{d(on)}	Turn-on Delay Time	V _{DD} =10V, I _D =2.5A, V _{GS} =10V, R _G =3Ω	--	6.8	--	nS
t _r	Turn-on Rise Time		--	57	--	nS
t _{d(off)}	Turn-Off Delay Time		--	14	--	nS
t _f	Turn-Off Fall Time		--	55	--	nS
Source- Drain Diode Characteristics						
V _{SD}	Forward on voltage	T _J =25°C, I _S =2.5A	--	--	1.2	V

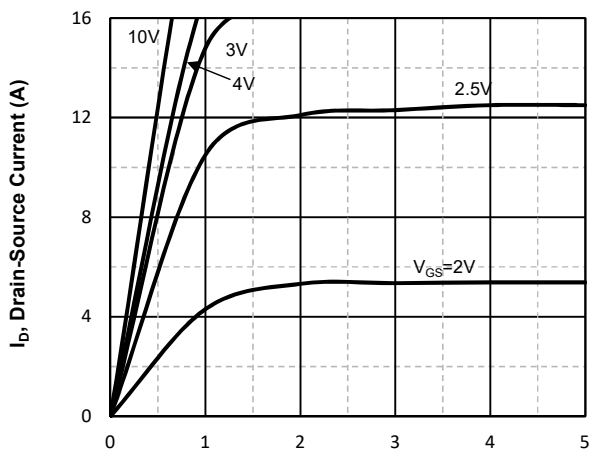
Typical Operating Characteristics


Fig1. Typical Output Characteristics

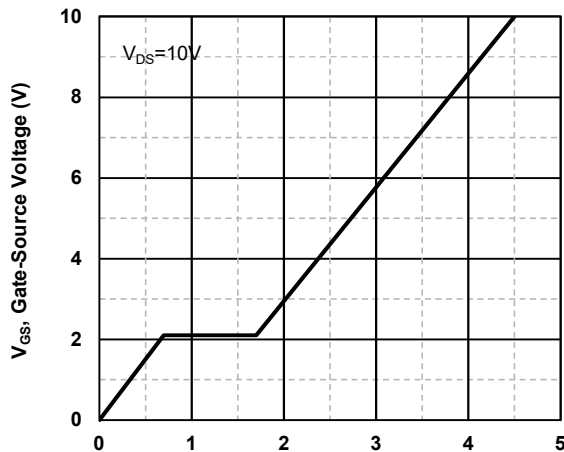


Fig2. Typical Gate Charge Vs. Gate-Source Voltage

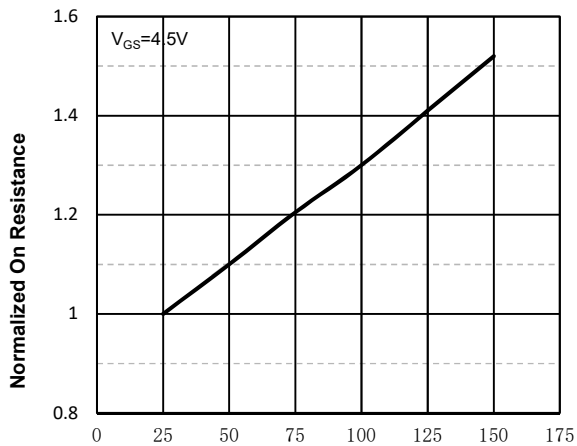


Fig3. Normalized On-Resistance Vs. Temperature

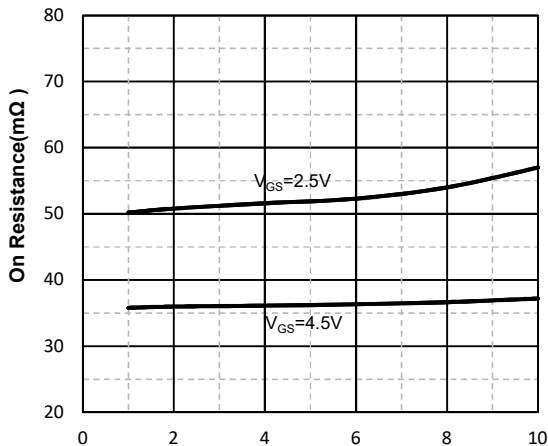


Fig4. On-Resistance Vs. Drain-Source Current

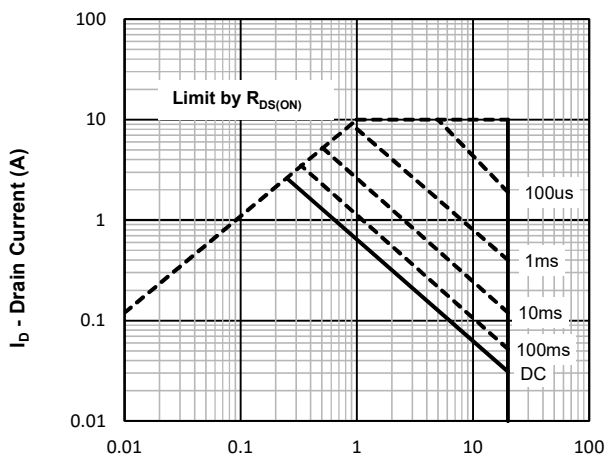


Fig5. Maximum Safe Operating Area

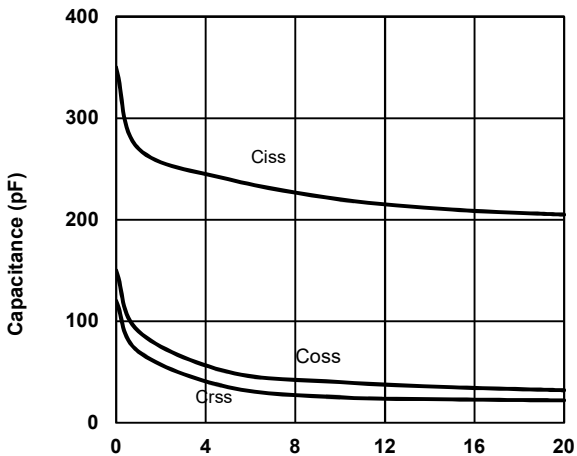
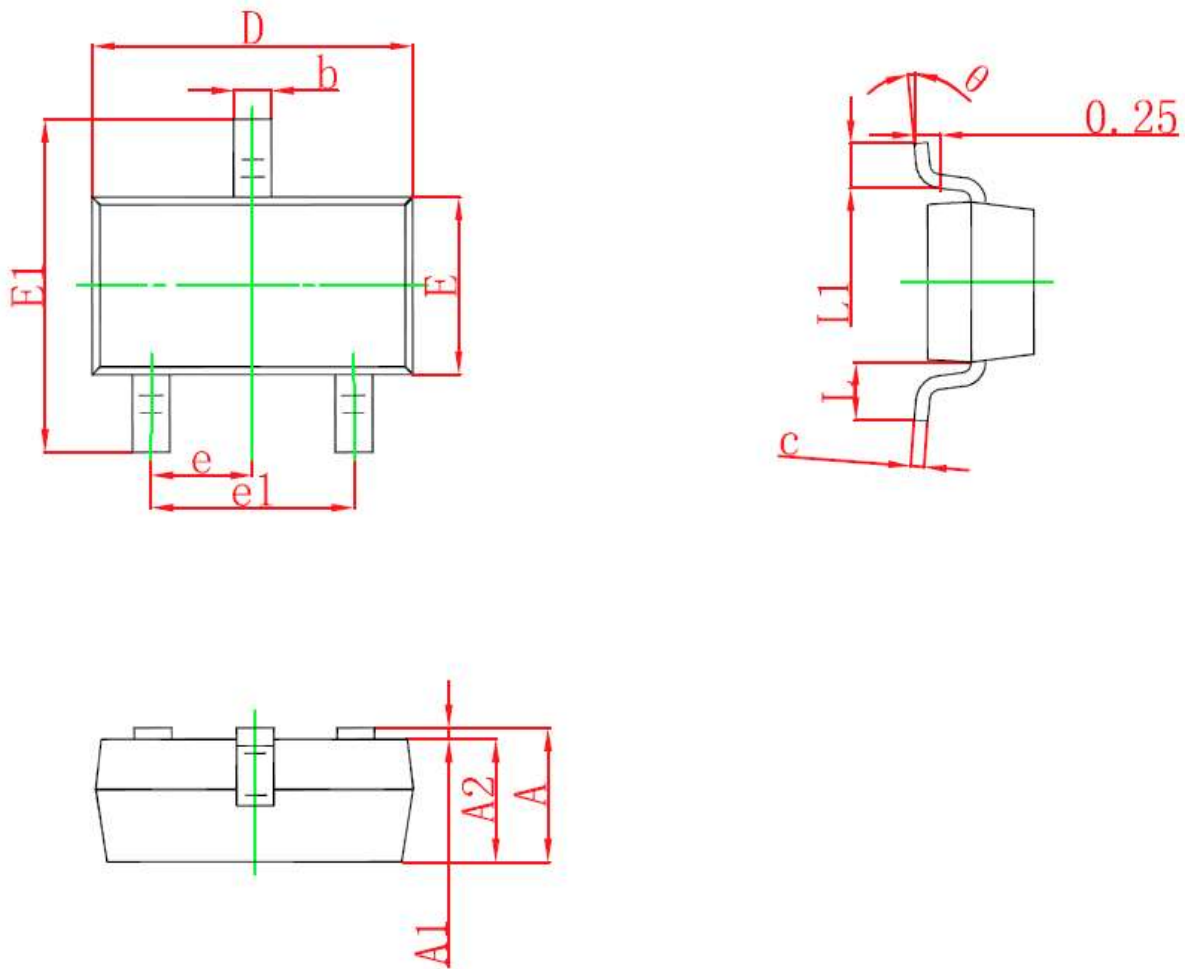


Fig6. Typical Capacitance Vs. Drain-Source Voltage

SOT-23 Package information


Symbol	Dimensions in Millimeters(mm)		Dimensions In Inches	
	Min	Max	Min	Max
A	0.900	1.150	0.035	0.045
A1	0.000	0.100	0.000	0.004
A2	0.900	1.050	0.035	0.041
b	0.300	0.500	0.012	0.020
c	0.080	0.150	0.003	0.006
D	2.800	3.000	0.110	0.118
E1	2.250	2.550	0.088	0.100
E	1.200	1.400	0.047	0.055
e	0.950TYP		0.037TYP	
e1	1.800	2.000	0.071	0.079
L	0.550 REF		0.022 REF	
L1	0.300	0.500	0.012	0.020
θ	0°	8°	0°	8°